



ELECTROSTATIC SENSITIVE DEVICE
OBSERVE HANDLING PRECAUTIONS

MITSUBISHI RF POWER MOS FET

RD00HHS1

RoHS Compliance, Silicon MOSFET Power Transistor 30MHz,0.3W

DESCRIPTION

RD00HHS1 is a MOS FET type transistor specifically designed for HF RF amplifiers applications.

FEATURES

High power gain
Pout>0.3W, Gp>19dB @Vdd=12.5V,f=30MHz

APPLICATION

For output stage of high power amplifiers in HF Band mobile radio sets.

OUTLINE DRAWING

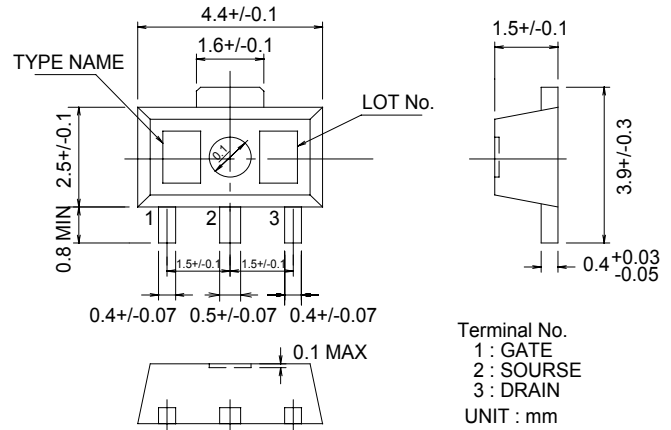

RoHS COMPLIANT

RD00HHS1-101,T113 is a RoHS compliant products.

This product include the lead in high melting temperature type solders.

How ever,it applicable to the following exceptions of RoHS Directions.

- 1.Lead in high melting temperature type solders(i.e.tin-lead solder alloys containing more than85% lead.)

ABSOLUTE MAXIMUM RATINGS

(Tc=25°C UNLESS OTHERWISE NOTED)

SYMBOL	PARAMETER	CONDITIONS	RATINGS	UNIT
Vdss	Drain to source voltage	Vgs=0V	30	V
Vgss	Gate to source voltage	Vds=0V	±10	V
Pch	Channel dissipation	Tc=25°C	3.1	W
Pin	Input power	Zg=Zl=50Ω	10	mW
ID	Drain current	-	200	mA
Tch	Channel Temperature	-	150	°C
Tstg	Storage temperature	-	-40 to +125	°C
Rth j-c	Thermal resistance	Junction to case	40	°C/W

Note 1: Above parameters are guaranteed independently.

ELECTRICAL CHARACTERISTICS

(Tc=25°C, UNLESS OTHERWISE NOTED)

SYMBOL	PARAMETER	CONDITIONS	LIMITS			UNIT
			MIN	TYP	MAX.	
Idss	Zero gate voltage drain current	VDS=17V, VGS=0V	-	-	25	uA
Igss	Gate to source leak current	VGS=10V, VDS=0V	-	-	1	uA
Vth	Gate threshold Voltage	VDS=12V, Ids=1mA	1	2	3	V
Pout	Output power	VDD=12.5V, Pin=4mW,	0.3	0.7	-	W
ηD	Drain efficiency	f=30MHz, Idq=50mA	55	65	-	%

Note : Above parameters , ratings , limits and conditions are subject to change.



ELECTROSTATIC SENSITIVE DEVICE
OBSERVE HANDLING PRECAUTIONS

MITSUBISHI RF POWER MOS FET

RD00HHS1

RoHS Compliance, Silicon MOSFET Power Transistor 30MHz,0.3W

TYPICAL CHARACTERISTICS

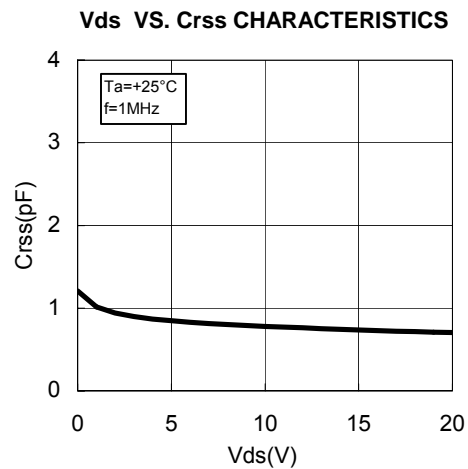
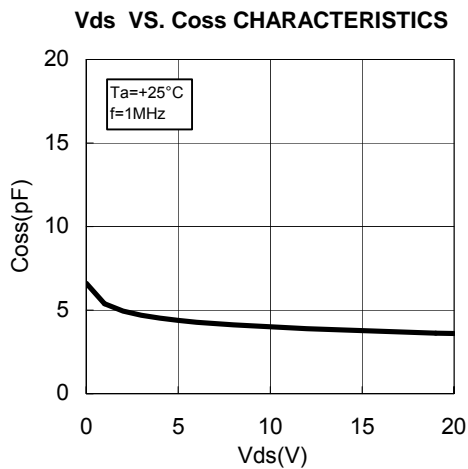
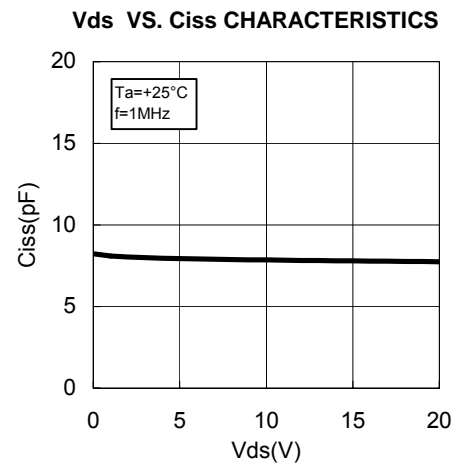
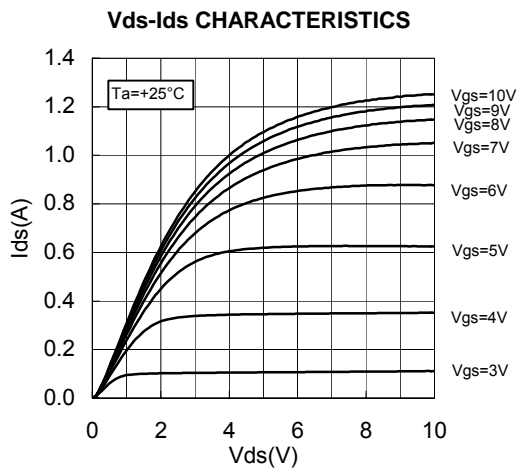
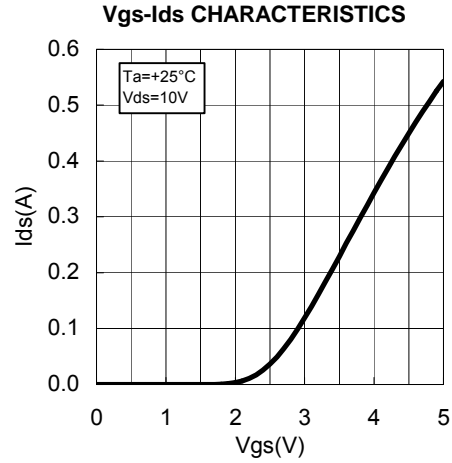
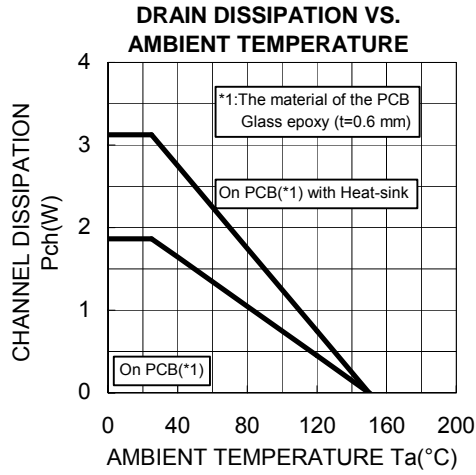

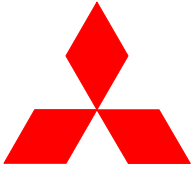

ELECTROSTATIC SENSITIVE DEVICE
OBSERVE HANDLING PRECAUTIONS

MITSUBISHI RF POWER MOS FET

RD00HHS1

RoHS Compliance, Silicon MOSFET Power Transistor 30MHz,0.3W

TYPICAL CHARACTERISTICS

Pin-Po CHARACTERISTICS

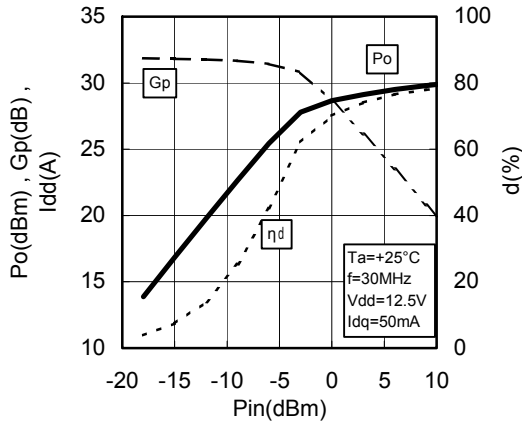

Pin-Po CHARACTERISTICS

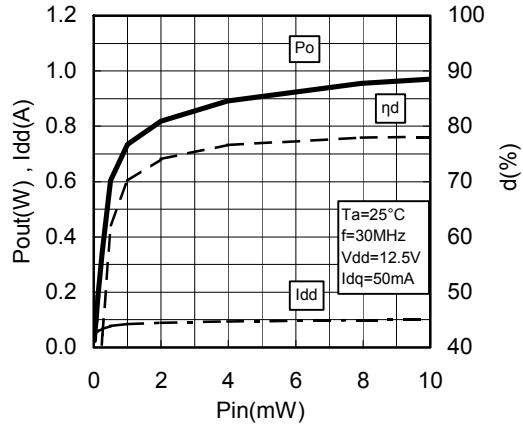

Vdd-Po CHARACTERISTICS

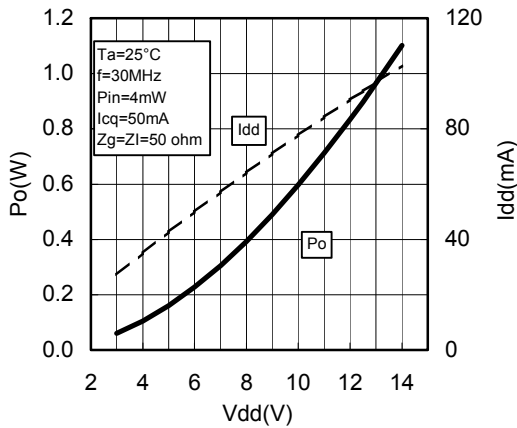

Vgs-Ids CHARACTERISTICS 2

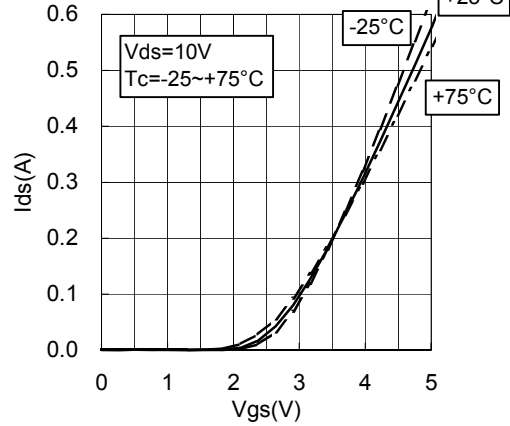

Vgs-gm CHARACTERISTICS

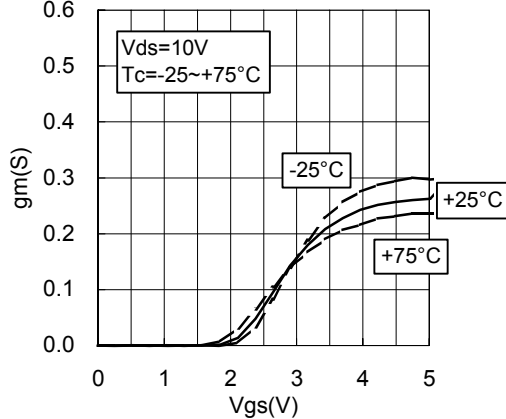

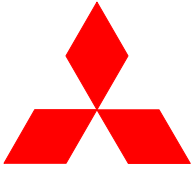

ELECTROSTATIC SENSITIVE DEVICE
OBSERVE HANDLING PRECAUTIONS

MITSUBISHI RF POWER MOS FET

RD00HHS1

RoHS Compliance, Silicon MOSFET Power Transistor 30MHz,0.3W

TEST CIRCUIT(f=30MHz)

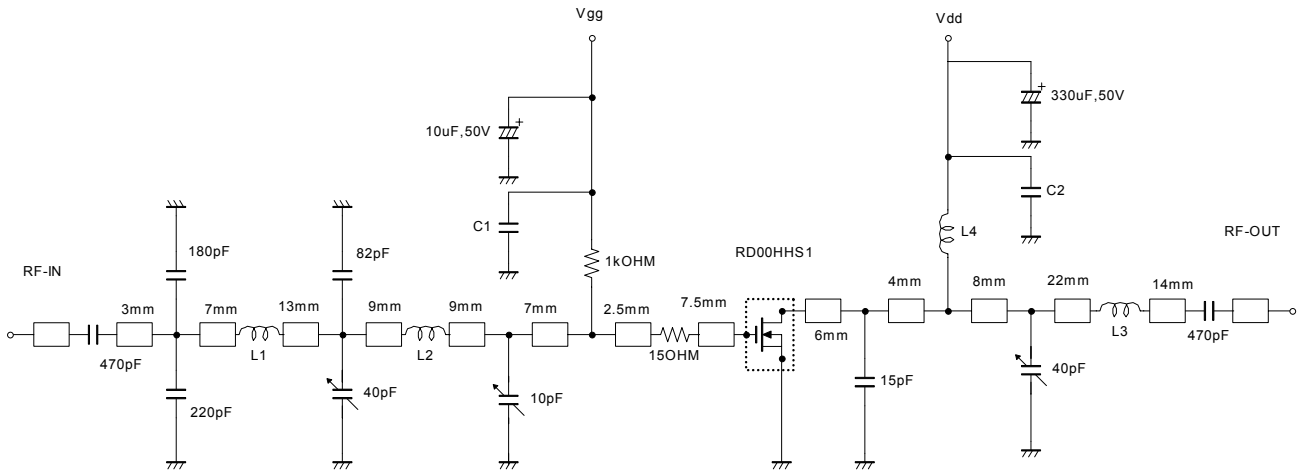

L1:LAL04NAR27(0.27mH)

L2:LAL04NAR39(0.39uH)

L3:LAL04NAR39(0.39uH)

L4:LAL04NA1R0(1uH)

C1,C2:100pF,0.022uF,0.1uF in parallel

Note:Board material-glass epoxy substrate

Micro strip line width=1.0mm/50OHM,er:4.8,t=0.6mm

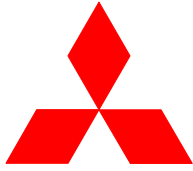

ELECTROSTATIC SENSITIVE DEVICE
OBSERVE HANDLING PRECAUTIONS

MITSUBISHI RF POWER MOS FET

RD00HHS1

RoHS Compliance, Silicon MOSFET Power Transistor 30MHz,0.3W

RD00HHS1 S-PARAMETER DATA (@V_{dd}=12.5V, I_d=50mA)

Freq. [MHz]	S11		S21		S12		S22	
	(mag)	(ang)	(mag)	(ang)	(mag)	(ang)	(mag)	(ang)
10	1.002	-3.6	12.533	178.3	0.003	90.3	0.920	-2.7
30	1.003	-9.9	12.631	174.6	0.008	82.8	0.919	-6.9
50	1.005	-16.8	12.784	170.6	0.013	79.5	0.918	-11.2
100	1.007	-33.5	12.820	159.1	0.025	67.4	0.898	-22.4
150	0.989	-49.8	12.355	147.5	0.035	56.5	0.866	-32.8
200	0.963	-64.0	11.571	136.8	0.042	47.5	0.824	-42.2
250	0.936	-76.9	10.697	127.3	0.048	38.2	0.781	-50.4
300	0.911	-87.9	9.791	119.1	0.053	30.6	0.745	-57.9
350	0.892	-97.7	8.972	111.4	0.055	24.6	0.711	-64.6
400	0.872	-106.2	8.202	104.9	0.057	18.5	0.685	-70.2
450	0.857	-113.7	7.533	98.9	0.058	13.1	0.665	-75.5
500	0.846	-120.1	6.921	93.4	0.058	8.7	0.649	-80.5
550	0.834	-126.0	6.386	88.4	0.059	4.7	0.640	-85.2
600	0.830	-131.0	5.894	83.7	0.058	0.2	0.630	-89.2
650	0.826	-135.9	5.484	79.3	0.057	-2.8	0.625	-93.3
700	0.821	-140.2	5.097	75.1	0.056	-6.9	0.623	-97.1
750	0.815	-144.0	4.749	71.0	0.055	-9.8	0.623	-100.7
800	0.812	-147.5	4.443	67.3	0.053	-13.0	0.623	-104.3
850	0.814	-151.0	4.167	63.8	0.051	-15.0	0.627	-107.7
900	0.816	-153.9	3.904	60.1	0.049	-17.6	0.630	-110.9
950	0.811	-156.8	3.670	56.8	0.048	-20.8	0.634	-113.9
1000	0.814	-159.5	3.471	53.7	0.046	-22.2	0.640	-117.1

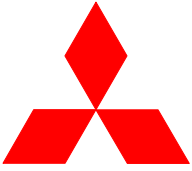

ELECTROSTATIC SENSITIVE DEVICE
OBSERVE HANDLING PRECAUTIONS

mitsubishi RF POWER MOS FET

RD00HHS1

RoHS Compliance, Silicon MOSFET Power Transistor 30MHz,0.3W

Keep safety first in your circuit designs!

Mitsubishi Electric Corporation puts the maximum effort into making semiconductor products better and more reliable, but there is always the possibility that trouble may occur with them. Trouble with semiconductors may lead to personal injury, fire or property damage. Remember to give due consideration to safety when making your circuit designs, with appropriate measures such as (i) placement of substitutive, auxiliary circuits, (ii) use of non-flammable material or (iii) prevention against any malfunction or mishap.

warning !

Do not use the device at the exceeded the maximum rating condition. In case of plastic molded devices, the exceeded maximum rating condition may cause blowout, smoldering or catch fire of the molding resin due to extreme short current flow between the drain and the source of the device. These results causes in fire or injury.